

## T50 GNSS RECEIVER USER GUIDE



# Copyright © TokSurvey Information Technology Co., Ltd. 2025. All rights reserved.

No part of this document may be reproduced or transmitted in any form or by any ways without prior written consent of TokSurvey Information Technology Co., Ltd.

## Trademarks and Permissions

 and other TokNav trademarks are trademarks of TokSurvey Information Technology Co., Ltd.

All other trademarks and trade names mentioned in this document are the property of their respective holders.

## Notice

The purchased products, services and features are stipulated by the contract made between TokNav Information Technology and the customer. All or part of the products, services and features described in this document may not be within the purchase scope or the usage scope.

The information in this document is subject to change without notice. Every effort has been made in the preparation of this document to ensure accuracy of the contents, but all statements, information, and recommendations in this document do not constitute a warranty of any kind, express or implied.

 **Notice:** The contents here are special operations and need your special attention. Please read them carefully.

 **Warning:** The contents here are generally very important as the wrong operation may damage the machine. This can lead to the loss of data, or even break the system and endanger your safety.

In some countries or regions, the configuration (tuning/debugging) of devices operating in the EN 300 113 V3.1.1 standard 410–470 MHz band may be restricted by law. Users must ensure compliance with local laws and regulations before operation.

# Contents

---

<b>1. T50 Overview</b>	01
1.1 Appearance	01
1.2 Battery Indicator	02
1.3 Power On and Off	03
1.4 Insert a SIM Card	04
1.5 Charging	04
1.6 Packing List	05
<b>2. WEB UI</b>	07
2.1 System View	08
2.2 Device Firmware	09
2.3 Skyplot	10
2.4 Data Stream	12
2.5 Mode Config	15
2.6 Others Config	17
2.7 File	18
2.8 Log	19
2.9 Message Text	19
2.10 Data Config	23
2.11 ZXVPN	27
<b>3. tSurvey2.0 Basic Operations</b>	27
3.1 Software Installation and Uninstallation	27
3.2 Project Manager	28
3.3 Communication	29
3.4 Rover Mode Setting	31
3.5 Base Mode Setting	36
3.6 Static Mode Setting	39
3.7 Point Survey	40
3.8 Tilt Survey	45
3.9 Laser Survey	46
3.10 Point Stakeout	48
3.11 AR Stakeout (Communication mode needs to select WIFI)	51
3.12 Localization	54
3.13 Calibrate Point	56
3.14 Coordinate Point library	58
3.15 Export File	60
3.16 Device Information	61
<b>4. Device Activation and Software Registration</b>	61
4.1 Device Activation	61
4.2 Software Registration	62
<b>5. Built-in Radio</b>	63
5.1 Radio Protocol	63
5.2 Default Channel Frequency	64
<b>6. Technical Indicators</b>	65



# 1. T50 Overview





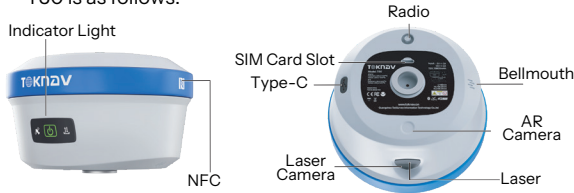

T50 is a full-featured GNSS receiver designed for long battery life and high precision. It includes an advanced positioning module supporting full-system and multi-frequency satellite signal tracking. Equipped with 4G universal connectivity, Bluetooth, WiFi, a 1.5W data radio, and a large-capacity battery, it can operate continuously for up to 16h on a single charge. The device integrates a high-precision inertial navigation system combined with AR and laser camera technology for AR stakeout and laser measurement, and augmented reality plotting, making surveying tasks more efficient and convenient.

## 1.1 Appearance

T50 is as follows:





project	Function	Function or status
	Power Button	Function: Brief press for 1s to display the battery level; Long press for 3s to turn on the device when it is off; Long press for 3s to turn off the device when it is on.
	Satellite Light	Rover/base station: 1 second interval flashing in the positioning state; when not searching for satellites, the light goes out; Static mode: flashes at intervals based on the sampling frequency.

	Differential Light	Rover mode: Blink when receiving differential data; Base mode: Blink when sending differential data.
	USB interface	Type-C interface, supports PD fast charging up to 33W, please refer to 1.5.
	SIM Card Slot	External SIM card, supports 4G full network access.
	UHF antenna interface	Built-in radio: supports low (0.5W) and high power (1.5W) options.
	Laser Camera	HD camera for tracking laser
	AR Camera	Professional ultra-wide-angle camera which provides high-definition real-scene stakeout.
	Laser	Millimeter-level laser ranging module, integrated with high-precision inertial navigation, and enables measurement at anytime and anywhere.

## 1.2 Battery Indicator

Press the power button for one second when the device is off; and the battery level can be informed based on the quantity of lights on.

Indicator Lights	Battery level
	0 % - 33%
	34 % - 66 %
	67 % - 100 %

## 1.3 Power On and Off

**Power On:** In the power-off state, press and hold the power button for 3 seconds until you hear the voice prompt “waiting to start.” Release the power button and wait for the panel indicator light to stop flashing alternately. Once you hear the voice prompt “communication connection successful,” the device has completed the power-on process.

**Power Off:** In the power-on state, press and hold the power button for 3 seconds until you hear the voice prompt "Power off." Wait for all the panel indicator lights to go out, indicating that the device has completed the power-off process.

**Forced Shutdown:** In case of unexpected malfunction, press and hold the power button for 10 seconds, and the device will shut down automatically.

## 1.4 Insert a SIM Card

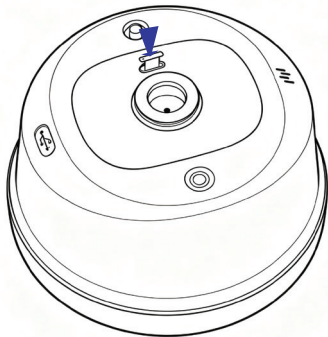

The device supports network working mode, a 4G full network solution based on the Linux platform, and fully supports China Mobile/China Unicom/China Telecom 2/3/4G networks, with better compatibility, stronger signals and more stable connections.

### How to insert a SIM card?

1. Open the rubber cover;
2. Insert the SIM card into the slot according to the instructions (chip facing the connector and notch facing the slot);
3. Put on the rubber cover.

## 1.5 Charging

The device comes with a Type-C charger that supports up to 33W PD fast charging. The battery can be fully charged in just 4 hours. And the battery indicator light shows:

Red light: The battery is charging;





Green light: The battery is fully charged.

**Battery charging:** Open the rubber cover, connect one end of the data cable to the Type-C port and the other end to the charger.

**Note:** For the safety of your device, please use the adapter that comes with the package or a brand adapter that complies with 3C certification for charging.

## 1.6 Packing List

After receiving and unpacking the package, please check whether the device and all accessories are complete according to the following table.

Serial number	name	model	quantity	picture	Remark
1	Geodetic GNSS Receiver	T50	1		Standard
2	450-470M Radio Antenna	AT0038	1		Standard
3	CC Data Cable	L0602-1	1		Standard
4	33W PD Power Adapter	CG0004	1		Standard
5	T50 yellow PP box packaging		1		Standard

6	PCR100T	BB0036	1		Optional
7	P9N controller bracket	BB0037	1		Optional
8	Type-C Data Cable	L0602-2	1		Standard
9	5V/2V USB Power Adapter	CG0003	1		Standard

## 2. WEB UI

The device WIFI can be used as a hotspot, which can be connected with a PC, smartphone or tablet. After connecting to the hotspot, you can log in to the device's Web UI Manage work status, change work mode, modify basic settings, download raw data, update firmware, and register devices, etc.

Taking your computer's interface as an example, enter the Web UI and do the following:

1. Use a computer to find and connect to the device's WIFI hotspot. Hotspot name: device serial number, and the default password is empty.

2. Open the web browser and input the IP address 10.10.10.10. The interface is shown in Figure 2-1.

The screenshot shows the Web UI interface for device W54276861000018. The top navigation bar includes System View, Device Firmware, Skyplot, Data Stream, Mode Config, and Others Config. The main content area is divided into three sections:

- GNSS Status:**
  - Quality: Differential sbac
  - DRT: 1
  - Longitude: 113.43139728°  $\sigma = 0.4223m$
  - Latitude: 23.16499883°  $\sigma = 0.3934m$
  - Height: -6.7221+29.3588-1.6960+20.9408m
  - PDOP: 1.68
  - HDOP: 0.65
  - HRMSE: 0.5772m
  - VRMSE: 0.8658m
  - Refstation ID: 178
- Register Info:**
  - SN: W54276861000018
  - Model: 353
  - Register Code: ED0A3E15185808F8
  - Expired Date: 2024-10-27
  - Functionality: dv0000
  - Scheme: None
  - Exception: None

Buttons:
- Working Mode:**
  - Working Mode: Rover Mode
  - Station Name: W54276861000018
  - Elev Cutoff: 5
  - Diff Age Max: 60s
  - Data Link: Bluetooth
  - Diff Stream: 0 B/s S416289 B

Copyright © 2003 - 2024, Guangzhou TokSurvey Information Technology Co.,Ltd

Figure 2-1

3. Meaning of icons arranged horizontally above the interface:

45/50	33.2 °C	0.000 V	0.000 V	7.875 V	75%
Satellite Used/Tracked	Temperature	Extended Voltage	Supply Voltage	Battery Voltage	Battery Info

### 2.1 System View

① GNSS Status: Quality, diff, Longitude, latitude, Height, accuracy, Ref station ID;

② Register info: SN, Model, Register Code, Expired Date, Functionality, Scheme, Exception;

③ Working mode: working mode, Station name, Elev cutoff, Diff Age Max, Data Link, Diff Stream.

④ Device Operation:

1) System command: shut down and restart the device

2) Configuration and data: reset configuration, clean storage, export configuration, and import configuration;

3) Registration code: The registration code is a valid time code that authorizes the device positioning function. When the registration code is found to have expired and the device positioning function is unavailable, you can obtain a new registration code from the supplier by providing the device number, enter it into this page, and click [Register] to register. The page effect is shown in Figure 2.1-1.

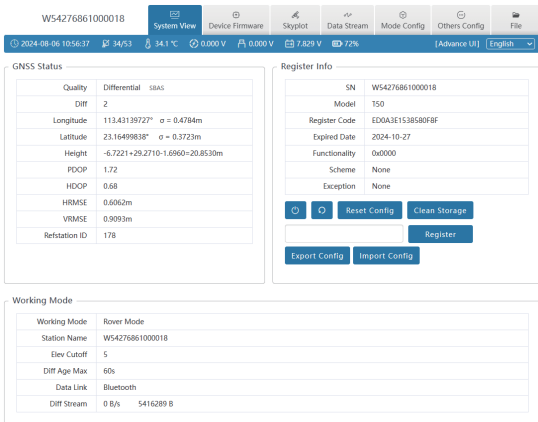

Figure 2.1-1

## 2.2 Device Firmware

The device firmware displays the Device Info, System Version and a local upgrade button, as shown in Figure 2.2.

① Device Info: SN, Hardware, GNSS Type, GNSS SN, GNSS Hardware, IMEI, Feature, Product Date, Brand, Model, and Board SN.

② System Version: system, Linux Version, positioning board, tilt module, radio firmware version, device firmware version.

Click the local upgrade below to automatically identify the positioning board firmware, tilt module firmware and device firmware that need to be upgraded. The specific steps are as follows:

1. Click [Local Upgrade];
2. Select the correct device firmware in the pop-up window, upload the firmware and wait for the device to restart;
3. After the restart is completed, the firmware upgrade is completed;
4. Reconnect the device to WIFI, enter the WEB UI, and check whether the firmware is upgraded successfully.

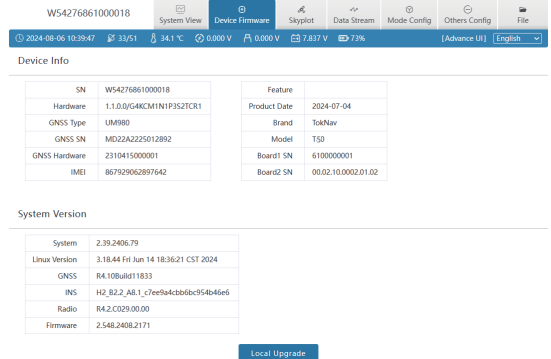

Figure 2.2

## 2.3 Skyplot

This diagram mainly displays satellite tracks and satellite status diagrams, for example, traces, satellite lists, status, etc., as shown in Figure 2.3-1:

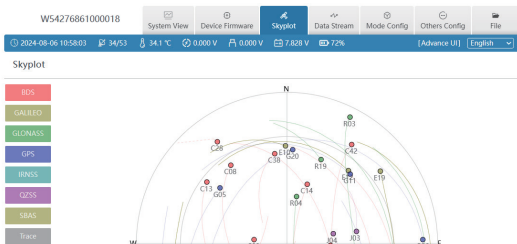

Figure 2.3-1

- ① GNSS System: Elev Cutoff: Set the Elev Cutoff;
- ② Satellite List: There are many satellite systems available, such as BDS, GALILEO, GPS, GALONASS, etc. If you find that the device receives fewer satellites under normal conditions, you can enter the page to check whether all satellite systems are turned on, click the small box at the back to turn on/off the corresponding satellite system.
- ③ SBAS: Choose to turn on or off the satellite-based augmentation system;
- ④ PPP: Select to disable or enable PPP mode, as shown in Figure 2.3-2

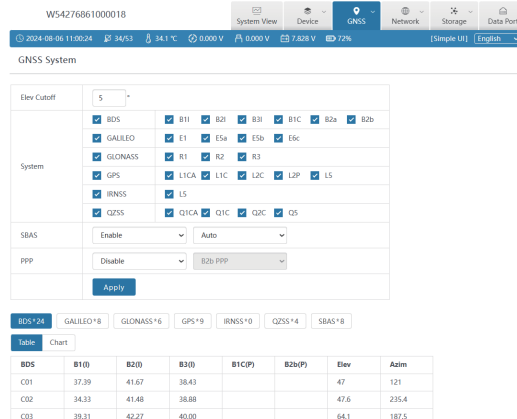

Figure 2.3-2

## 2.4 Data Stream

Data stream is mainly used to debug data information. You can view the status of current data, as shown in Figure 2.4-1:

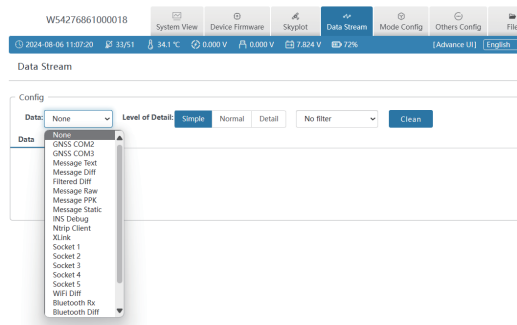

Figure 2.4-1



## 2.5 Mode Config

① Working mode: You can select Rover Mode/ Base Mode/Static Mode, and select the Elev Cutoff at the same time;

1. Rover Mode: the following parameters (Station Name, Elev Cutoff, Diff Age Max, Height Type, Antenna Height, Record, PPK) can be configured, as shown in Figure 2.5-1:

The screenshot shows the 'Mode Config' window for station W54276861000018. The 'Mode' is set to 'Rover Mode'. The configuration parameters are: Station Name: W54276861000018; Elev Cutoff: 5 Degree; Diff Age Max: 60 Second; Height Type: Phase; Antenna Height: 1.6960 Meter; Record: Enable; PPK: Disable (not affect by Record).

Figure 2.5-1

2. Base Mode: You can configure parameters (Station Name, Elev Cutoff, Station ID, PDOP Threshold, Diff Type, Base Mode, Height Type, Antenna Height, Record), as shown in Figure 2.5-2:

The screenshot shows the 'Mode Config' window for station W54276861000018. The 'Mode' is set to 'Base Mode'. The configuration parameters are: Station Name: W54276861000018; Elev Cutoff: 5 Degree; Station ID: 0; PDOP Threshold: 3.0000; Diff Type: RTCM32; Base Mode: Auto; Height Type: Phase; Antenna Height: 1.6960 Meter; Record: Enable.

Figure 2.5-2

3. Static mode: the following parameters (Station Name, Elev Cutoff, PDOP Threshold, Sample Interval, Height Type, Antenna Height, Record) can be configured, as shown in Figure 2.5-3:

The screenshot shows the 'Mode Config' window for station W54276861000018. The 'Mode' is set to 'Static Mode'. The configuration parameters are: Station Name: W54276861000018; Elev Cutoff: 5 Degree; PDOP Threshold: 3.0000; Sample Interval: 1 Hz; Height Type: Phase; Antenna Height: 1.6960 Meter; Record: Enable; File Type: GNSS.

Apply

Figure 2.5-3

② Data link: You can choose No Data link/Bluetooth/WIFI /Built-in Network/Built-in Radio /External radio /XLink/PPP, as shown in Figure 2.5-4:

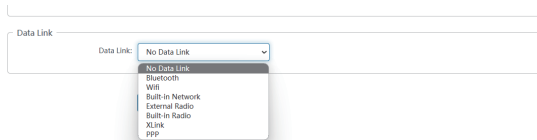

Figure 2.5-4

1. Bluetooth: the device obtains the differential data of tSurvey2.0 software accessed by the controller network through Bluetooth connection;

2. Built-in network: the device receives or sends data through the built-in network. To select this data link, please insert the SIM card into the device first;

3. Built-in Radio: the device receives data via the built-in radio. To select this data link, please connect the radio antenna to the device first.

## 2.6 Others Config

① WIFI: You can choose from three types: Disable/AP /Station, and you can set the WIFI name and password by yourself. When the device WIFI is used as the Station, you can access the network by entering the name and password of the external hotspot.

② Others: You can select the device's UTC time and set it according to your region. The interface is shown in Figure 2.6-1:

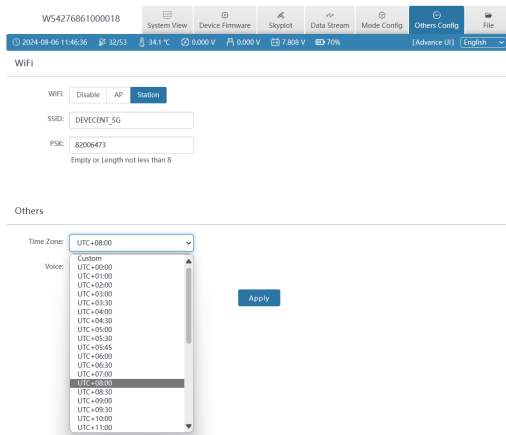

Figure 2.6-1

## 2.7 File

In this interface, you can batch delete the data folders in the device, as shown in Figure 2.7.1; enter the file directory and you can choose to download the data of each channel, as shown in Figure 2.7.2.



Figure 2.7-1

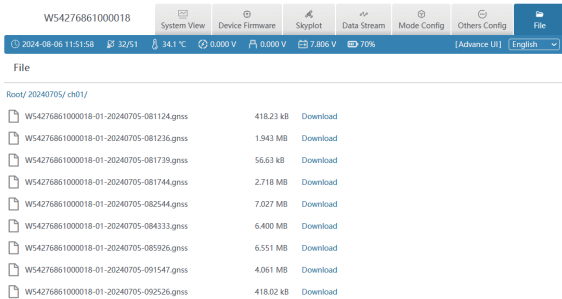

Figure 2.7-2

## 2.8 Log

It provides the download of equipment operation logs. When an abnormality occurs during the use of the equipment, you can download the logs generated at the corresponding time and provide them to our company so that we can troubleshoot the problem for you, as shown in Figure 2.8:

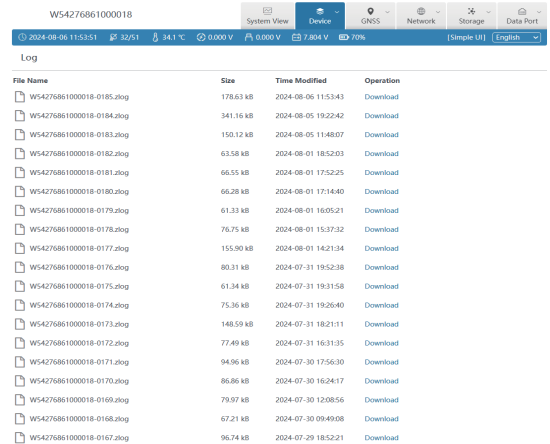

Figure 2.8

## 2.9 Message Text

You can set the type and frequency of text format output data, as shown in Figure 2.9. After the configuration, you can check whether there is corresponding text data output in 2.4 of this section.

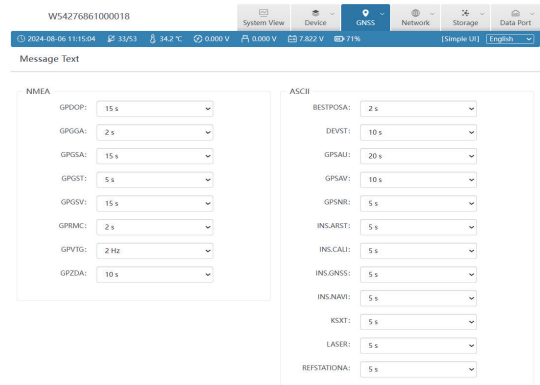

Figure 2.9

The following are the formats of several common message text:

\$GPGGA
Example: \$GPGGA,092204.999,4250.5589,S,14718.5084,E,1,04,24.4,19.7,M,,,,,0000*1F
Field 0: \$GPGGA, statement ID, indicating that the statement is Global Positioning System Fix Data (GGA) GPS positioning information
Field 1: UTC time, hhmmss.sss, in hour, minute, second format
Field 2: Latitude ddmn.mmmm, in degree and minute format (if the leading digits are insufficient, fill them with 0)
Field 3: Latitude N (North) or S (South)
Field 4: Longitude dddmm.mmmm, in degree and minute format (if the leading digit is insufficient, add 0)
Field 5: Longitude E (East) or W (West)
Field 6: GPS status, 0 = not positioned, 1 = non-differential positioning, 2 = differential positioning, 3 = invalid PPS, 6 = estimating
Field 7: Number of satellites in use (00 - 12) (if the leading digit is insufficient, fill it with 0)
Field 8: HDOP horizontal dilution of precision (0.5 - 99.9)
Field 9: Altitude (-9999.9 - 99999.9)
Field 10: The height of the Earth's ellipsoid relative to the geoid
Field 11: Differential time (seconds from the last differential signal received, empty if not differential positioning)
Field 12: Differential station ID number 0000 - 1023 (if the leading digit is insufficient, it will be filled with 0, and it will be empty if it is not differential positioning)
Field 13: Checksum
\$GPGSV
Example: \$GPGSV,3,1,10,20,78,331,45,01,59,235,47,22,41,069,13,32,252,45*70
Field 0: \$GPGSV, statement ID, indicating that the statement is GPS Satellites in View (GSV) visible satellite information
Field 1: The total number of GSV statements this time (1 - 3)

Field 2: This GSV statement is the number of this GSV statement (1 - 3)
Field 3: Total number of currently visible satellites (00 - 12) (if the leading digit is insufficient, add 0)
Field 4: PRN code (pseudo-random noise code) (01 - 32) (if the leading digit is insufficient, add 0)
Field 5: Satellite elevation angle (00 - 90) degrees (if the leading digit is insufficient, fill it with 0)
Field 6: Satellite azimuth (00 - 359) degrees (if the leading digit is insufficient, fill it with 0)
Field 7: Signal-to-noise ratio (00-99) dBHz
Field 8: PRN code (pseudo-random noise code) (01 - 32) (if the leading digit is insufficient, add 0)
Field 9: Satellite elevation angle (00 - 90) degrees (if the leading digit is insufficient, fill it with 0)
Field 10: Satellite azimuth (00 - 359) degrees (if the leading digit is insufficient, fill it with 0)
Field 11: Signal-to-noise ratio (00-99) dBHz
Field 12: PRN code (pseudo-random noise code) (01 - 32) (if the leading digit is insufficient, fill it with 0)
Field 13: Satellite elevation angle (00 - 90) degrees (if the leading digit is insufficient, fill it with 0)
Field 14: Satellite azimuth (00 - 359) degrees (if the leading digit is insufficient, fill it with 0)
Field 15: Signal-to-noise ratio (00-99) dBHz
Field 16: Checksum

## 2.10 Data Config

The device has 24G storage space (recyclable storage) and supports five channels (CH01/CH02/CH03/CH04/CH05) to save various files, as shown below. We can control the data source, file period, file name and file format of each channel for storage as needed. The naming rules page has detailed instructions, as shown in Figure 2.10-1.

When the device is set to rover, base or static mode, the device will automatically control the corresponding channel for data storage by default.

**Note:** Do not change the mode after the device data configuration is completed, otherwise the default storage configuration will be restored.

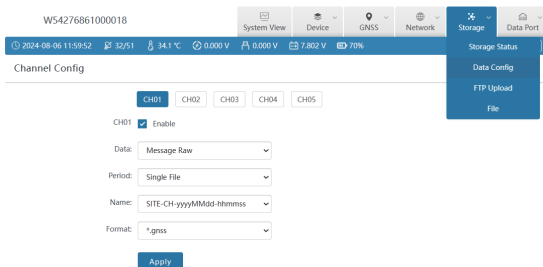

1. The time in file name is converted from GPS time directly.  
Assume GPS logs record is 1s, Time Zone offset is +0800, Then 00:00:18 means 08:00:00 of local time.

2. Key words in file name

```

yyyy    => year
MMdd   => month_01-12
dd      => day_01-31
hh      => hour_00-23
mm      => minute_00-59
ss      => second_00-59
DDYY   => day of year_000-366
X       => hour, a-x, 0 when one file per day
SN      => SN
SITE    => Marker Name
SSSS    => Marker Number
    
```

Figure 2.10-1

## 1. Rover (CH01)

When the device is set as a rover station, the device will automatically configure CH01 to store and locate the original data by default. If PPK is enabled, CH05 will also be automatically configured to store the post positioning data by default, as shown in Figure 2.10-2:

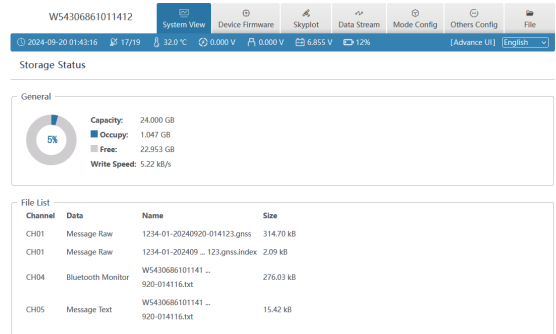

Figure 2.10-2

## 2. Base (CH02)

When the device is set as a base station, the device will automatically configure CH02 to store and locate raw data by default. If PPK is enabled, CH05 will also automatically configure the storage location for post-processed data by default, as shown in Figure 2.10-3:

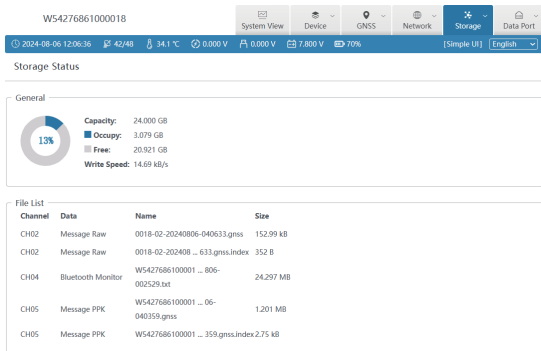

Figure 2.10-3

### 3. Static (CH03)

When the device is set to static mode, the device will automatically configure CH03 to store static positioning data by default, as shown in Figure 2.10-4:

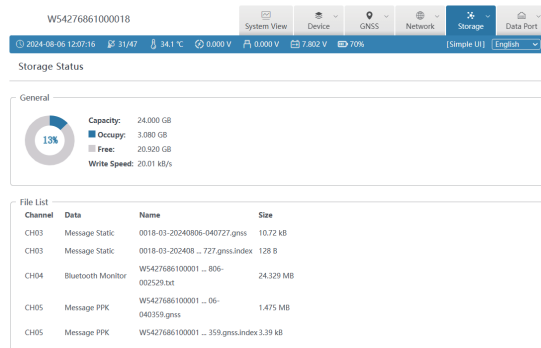

Figure 2.10-4

**Note:** Whenever the tSurvey2.0 software is connected to the device via Bluetooth, the device will automatically configure CH04 to store Bluetooth monitor data. If there are any problems with the settings of the Bluetooth connected device, you can download the recorded Bluetooth monitor data for troubleshooting, as shown in Figure 2.10-5:

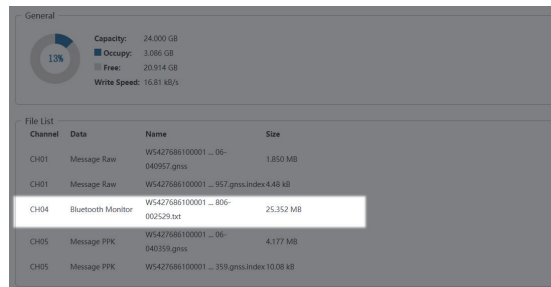

Figure 2.10-5

## 2.11 ZXVPN

ZXVPN can provide a virtual LAN, connect the device to the server, and access the Web UI in the background, providing corresponding remote technical support and services. The steps are as follows:

1. Insert a SIM card into the device;
2. Turn on the mobile network and make sure it is connected to the Internet, or connected to the WIFI;
3. Click [Use default value] to apply, as shown in Figure 2.11.

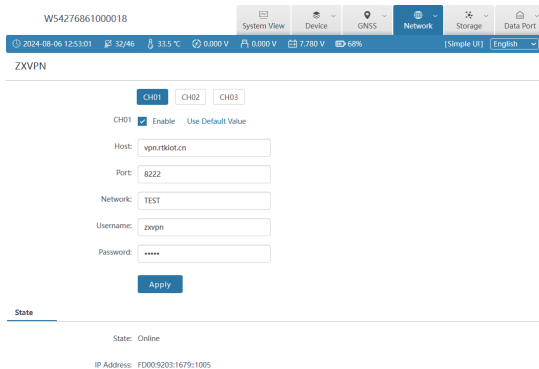

Figure 2.11

## 3. tSurvey2.0 Basic Operations

### 3.1 Software Installation and Uninstallation

Installation process:

1. Download the Android tSurvey2.0 program (\*.apk);
2. Copy the tSurvey2.0 program to your mobile phone (controller);

3. Find the program in the file management of the controller and install it;

4. Click on the tSurvey2.0 software on the desktop (you need to create a project for the first time, and the last project used will be automatically opened each time the software is started).

Uninstallation process:

Uninstall method: Long press the software icon on the desktop, drag to the [ Uninstall] option box, and click " OK " to complete the software uninstallation.

### 3.2 Project Manager

Click [ Project ] → [ Project Manager ], as shown in Figure 3.2-1. Project manager includes functions such as creating a new project, importing a project, exporting a project, deleting a project, and opening a project.

Click [Project Path] to modify the path of the project on disk. The default path is in the internal storage → tSurvey2.0 > Project directory.

Click [Details], as shown in Figure 3.2-2, to modify the basic properties of the project, such as Basic Information, Coordinate system parameter, and Code Library.

Click [ New ], as shown in Figure 3.2-3. To create a new project, you need to fill in the basic properties such as project name, whether to apply the project, and select the coding template. Click [ OK ] and fill in the coordinate system parameters used to modify the project, as shown in Figure 3.2-4. Click [OK] to complete the creation of the project.

Click on other items in the list, and the open function will appear, as shown in Figure 3.2-5. Long press on an item in the list, and the delete function will appear, as shown in Figure 3.2-6 (**Note:** you cannot delete a project that is in use).

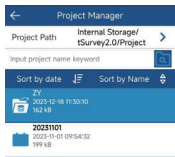

Figure 3.2-1

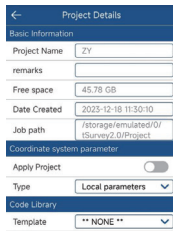

Figure 3.2-2

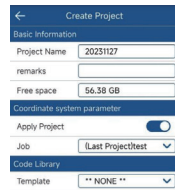

Figure 3.2-3

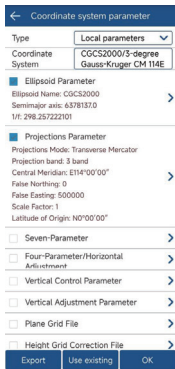

Figure 3.2-4

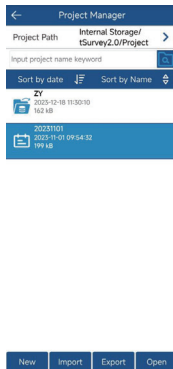

Figure 3.2-5

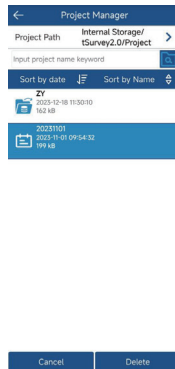

Figure 3.2-6

### 3.3 Communication

Click [Device]→[Communication] to enter the communication settings interface, as shown in Figure 3.3-1. Select the device type (RTK), communication mode

(Bluetooth), and then click [Search], as shown in Figure 3.3-2. View the Bluetooth device list, select the corresponding device serial number, and click [Connect] to complete the device connection, as shown in Figure 3.3-3. After the device is successfully connected, it will directly return to the device interface, as shown in Figure 3.3-4. Enter the communication settings again, as shown in Figure 3.3-5, and click [Stop] to disconnect the device. Click [Debug] to view the data of the software and device communication, as shown in Figure 3.3-6.

1. Communication mode includes Bluetooth, serial port, TCP client port, etc.;
2. Click [Search] and select the device you want to connect according to the device serial number;
3. After the device is successfully connected, click [Debug] to view the data of communication between the software and the device. You can also send debugging commands to the device to troubleshoot and analyze issues related to device positioning.



Figure 3.3-1



Figure 3.3-2

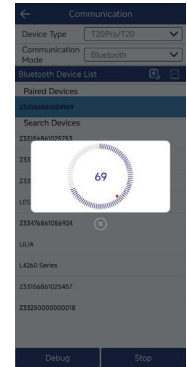

Figure 3.3-3

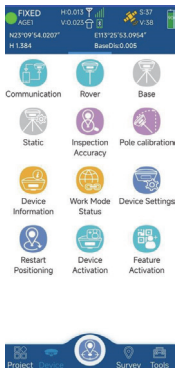

Figure 3.3-4

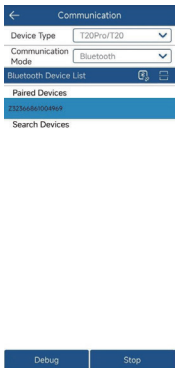

Figure 3.3-5



Figure 3.3-6

### 3.4 Rover Mode Setting

Click [Device] → [Rover], as shown in Figure 3.4-1. GNSS positioning equipment can calculate positioning coordinates by receiving satellite signals. In the absence of other interferences, the positioning equipment can only obtain the coordinate position of a single point solution due to the interferences of the atmosphere on the signal, and the accuracy is low. In order to ensure that GNSS devices can obtain high-precision positions, in addition to the GNSS device itself receiving satellite signals to calculate the position, it is also necessary to receive the signal of another nearby fixed-position GNSS device, and use the signal of the other device as the reference signal. Since the influence of the atmosphere on the signal is basically the same within a certain area, when the coordinate position of the reference signal is known, the two sets of GNSS can calculate the high-precision position. The GNSS device with a fixed position is called the base, and the GNSS device with a

non-fixed position is called the rover. Relative to the GNSS satellite signal of the rover, the data transmitted by the base is called differential data, and the data transmission method is called data link. The rover mode setting is to set the GNSS as a rover, configure certain parameters to transmit the GNSS satellite signal of the base station to the GNSS device in a certain way, so that the GNSS device can obtain a high-precision positioning.

In addition to differential data transmission configuration, you can also set the GNSS cutoff angle, differential delay, and whether to enable PPK and other basic information, as shown in Figure 3.4-1. Adjust the altitude angle to not receive the satellite signal when it is lower than a certain value. In the case of poor satellite signals at low angles, it is beneficial to precision calculation. The PPK parameter records the original GNSS observation data to the GNSS receiver and uses the post-processing algorithm to calculate high-precision coordinates.

The differential data parameter setting is mainly to set a way to transmit the differential data of the base station to the current device, so as to provide the necessary solution conditions for the device to solve high-precision coordinates. The data link methods mainly include Phone Internet, Device Internet, Internal Radio and other methods.

1. Phone Internet: As shown in Figure 3.4-1, it refers to obtaining differential data from the specified server address through the network of the device where the software is located according to a certain protocol, and then sending it to the device through the communication connection between the software and the GNSS device for high-precision solution. Click on the right side of CORS

settings  to enter the CORS server management interface, as shown in Figure 3.4-2. You can directly select, edit, and delete existing CORS servers, or manually add CORS server parameters, as shown in Figure 3.4-3. After correctly configuring the server address, obtain the access point list, as shown in Figure 3.4-4, and select the corresponding access point to obtain differential data. Click [Start], if the configuration is correct, the data reception progress bar will move. If there is no data in the progress bar, you need to confirm whether the parameter configuration is correct.

2. Device Internet: As shown in Figure 3.4-5, it refers to obtaining differential data from a specified server address through the SIM card network of the GNSS device according to a certain protocol for high-precision solution. The connection mode is the transmission protocol of differential data, usually by NRTIP, TCP client, etc., enter the server IP, port, username and password and other connection parameters. The SIM network is a dedicated network and needs to configure APN parameters, as shown in Figure 3.4-6. The CORS setting is similar to the Phone Internet. After correctly configuring the server address, obtain the access point list and select the corresponding access point to obtain differential data. In addition to obtaining access points through the Device Internet, it can also be obtained through the network corresponding to the mobile phone if there is a mobile phone with a network.

3. Internal Radio: As shown in Figure 3.4-7, it means receiving the differential data of the radio station according to a certain protocol and frequency through the internal radio of the GNSS device, and performing high-precision

calculation. At this time, it is necessary to ensure that the protocol and frequency of the built-in radio station are consistent with the protocol and frequency of the transmitting radio station, so that the radio station data can be received normally. If the frequency corresponding to the channel is inconsistent with the channel frequency of the transmitting radio station, you can click [Set Radio Frequency] to modify the frequency corresponding to each channel of the radio station, as shown in Figure 3.4-8.

4. XLINK: As shown in Figure 3.4-9, it is a differential forwarding system built based on the CORS network of Qianxun/ Liufen/ China Mobile. After configuring the Xlink data link, the host can access the differential normally if it can access the Internet, without the need for the customer to manually fill in the CORS account.

**Note:** Each data link has the base coordinate change alert turned on by default, because if the wrong base station signal is received, the coordinates may be inaccurate, reminding the user to check and confirm.

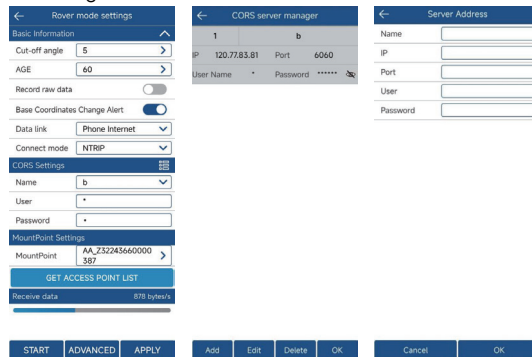

Figure 3.4-1

Figure 3.4-2

Figure 3.4-3

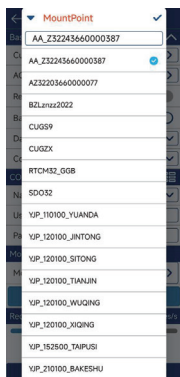

Figure 3.4-4



Figure 3.4-5



Figure 3.4-6

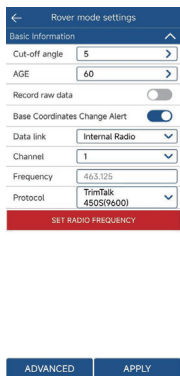

Figure 3.4-7



Figure 3.4-8

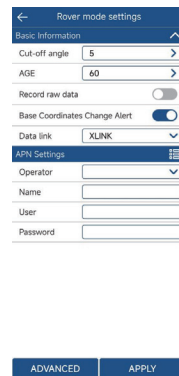

Figure 3.4-9

### 3.5 Base Mode Setting

Click [Device]→ [Base], as shown in Figure 3.5-1. This function is that the GNSS device acts as a base to send satellite information data in a certain way and provide it to the rover to receive it, providing it with high-precision solution conditions. The host needs to set the startup condition parameters, startup mode and data broadcast parameters as a base.

**Note:** During the startup of the base station, the device is not allowed to move, otherwise the coordinates calculated by the rover will be wrong.

The start-up conditions include Base ID, Diff Mode, cut-off angle, PDOP limit and other parameters. Click [Advanced], as shown in Figure 3.5-2, to configure cut-off angle, PDOP limit and other parameters. The differential data format includes CMR, RTD, RTCM23, RTCM30, RTCM32, RTCM33 and other commonly used differential data encoding formats;

The startup mode includes using Current coordinates, inputting Base coordinates, etc., among which:

1. Use Current coordinates: This means that the GNSS device outputs differential broadcast data for the startup coordinates based on the current positioning value (with low accuracy);
2. Input Base Coordinates: refers to the location where the user sets up the equipment. The user knows the coordinates of this location in advance and uses this coordinate value as the starting coordinate to output differential broadcast data. Click [ Specify Base Station Coordinates] to enter the interface for setting base station coordinates, as shown in Figure 3.5-3. You can click  the

measurement icon to measure a point in real time, or click  to select a coordinate value from the coordinate point library.

The data broadcast parameters are mainly the differential data output by the device after starting the base station, which is transmitted through a certain method and received and used by the rover. The main methods include device Internet, built-in radio, external radio, etc. The parameter settings are similar to those of the rover, with the following differences:

1. The internal radio has a transmission power. The higher the transmission power, the longer the effective distance, and the greater the power consumption;
2. Device Internet NTRIP protocol, the base station is the base station access point that sets the start of transmission, as shown in Figure 3.5-1, and the rover obtains the access point list and selects the corresponding base station access point to connect;
3. The base station uses an external radio to broadcast differential data, as shown in Figure 3.5-4. The baud rate must be consistent with the connected external radio;
4. For CORS settings, refer to the rover data link for corresponding configuration.

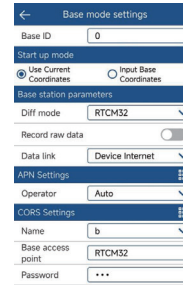

Figure 3.5-1



Figure 3.5-2

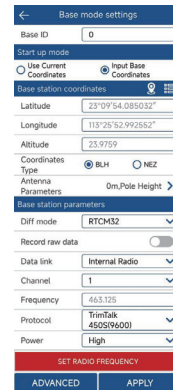

Figure 3.5-3



Figure 3.5-4

### 3.6 Static Mode Setting

Click [Device]→[Static Mode], as shown in Figure 3.6-1. This function is to store the original satellite observation data of the GNSS device into the set disk file, record the observation data of a period of time for the use of static post-processing software to solve the high-precision coordinate position, usually used for control point acquisition. To start the static mode, you need to set the static file point name, PDOP limit, cut-off angle, Collection interval, antenna parameters and File Format and other recording conditions, as shown in Figure 3.6-2.

Click [Start] to start static collection, as shown in Figure 3.6-3, and click [Stop] to end static collection. The status will display information such as Record Status, Start Time, Epoch number, and Record file.

**Note:** During static recording, the device is not allowed to move, otherwise it will cause errors in the coordinates calculated by post-processing.

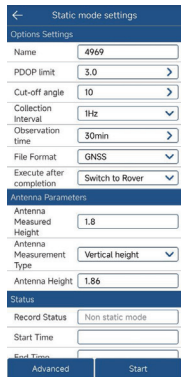

Figure 3.6-1

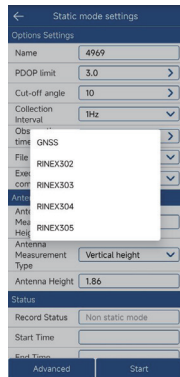

Figure 3.6-2

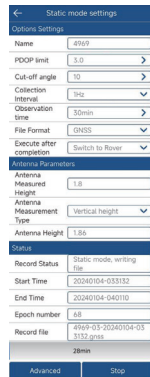







Figure 3.6-3

### 3.7 Point Survey

Click [Survey] → [Point Survey], as shown in Figure 3.7-1. The positioning output by the GNSS device is measured and collected according to certain accuracy constraints and stored in the coordinate point library. In the point survey interface, the top title bar displays the basic information of the positioning output by the current GNSS device, the current solution status, differential delay, HRMS, VRMS and other positioning accuracy assessment values, and the number of received satellites. Below the title bar is the status bar that displays other important information. The display content can be configured according to the user's demand. In point survey, the north-east high coordinates and base station distance information are displayed by default. The middle area is the measurement data drawing information, and the network map can also be set to display.

The icon  in the upper left corner of the drawing area indicates the direction of the map, which is convenient for users to determine the direction when needed. The lower left corner of the drawing area shows the scale of the drawing. Click the icon  or  on the right to enlarge or reduce the scale of the drawing. Below the drawing area is the display of function collection. These function menus can also be displayed here according to the needs of the user in the settings to quickly operate certain functions.

The icon  in the lower right corner of the drawing area is the button to trigger the survey collection function. This button can be moved according to the user's usage habits and placed in a more convenient place for operation. Click the button to start the survey function, as shown in Figure 3.7-2. You can enter the point name and code. Click

the icon  to select the preset code in the code library to quickly fill in the attributes of the feature. If there are many codes in the code library, the codes with higher frequency of use will be displayed in the front to facilitate users to quickly select.

Below the drawing area are the measurement type selection, coordinate point library entry, antenna height setting, and tool menu.

Click [Topo Point], as shown in Figure 3.7-3. Four types of point will pop up: Topo Point, Control Point, Quick Point, and Auto Point. You can select the corresponding point type for surveying according to actual needs.



Click [Point Library] to enter the coordinate point library interface, as shown in Figure 3.7-4, where you can view the surveying point status.

Click the icon  to modify and edit the antenna height information, as shown in Figure 3.7-5. The antenna height setting is to subtract the antenna height from the phase center coordinates of the GNSS to get the actual position of the measured target on the ground. If the antenna information is incorrect, click the antenna information to select the correct antenna type in the antenna management (used when the GNSS device does not output antenna information or uses an external antenna).

Click [Tools], as shown in Figure 3.7-6, you can quickly operate certain functions in the menu as needed, or you can add and delete functions in the toolbar according to user needs in the settings.

Click the icon  to enter the surveying setting interface, as shown in Figure 3.7-7. Set the measurement collection restriction conditions here, such as the solution

limit, HRMS Limit, VRMS Limit, PDOP Limit, AGE Limit, etc. Users set the LIMIT conditions according to the accuracy requirements of the operation. Setting the number of smoothing points is to collect multiple positioning points and calculate the average value to indicate the accuracy. In addition, you can also set the default point name and default code, etc. The information bar is to set the display content of the status information bar. Users can set the display according to the information they focus on, as shown in Figure 3.7-8. The toolbar is for users to set common functions according to their needs during the operation, so that users can quickly and conveniently call certain functions, as shown in Figure 3.7-9. These functions include: Auto JUMP, Switch Map, ROSE mode, Take screen point, CAD text, coordinates converter, Perimeter and area, CAD background color, etc. Click the menu icon on the toolbar to trigger the corresponding function.

Click the icon  to automatically center the current position on the screen. Click the icon  to display all current measurement points on the screen.

Click the icon , as shown in Figure 3.7-10, to turn on/off the tilt measurement function.

Click the icon, as shown in Figure 3.7-11 and Figure 3.7-12, to select the network map you want to display.



Figure 3.7-1



Figure 3.7-2

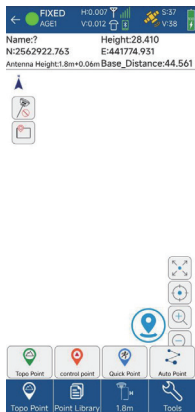

Figure 3.7-3

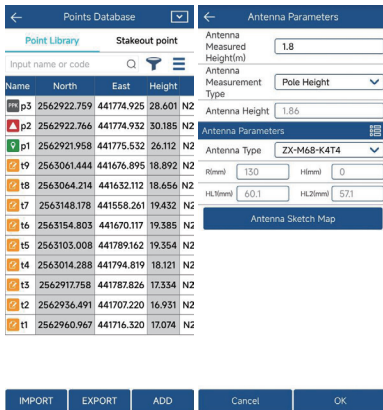

Figure 3.7-4

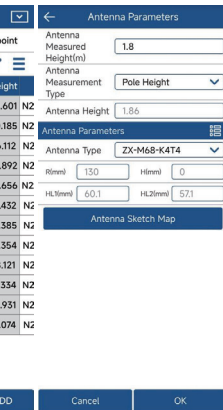

Figure 3.7-5

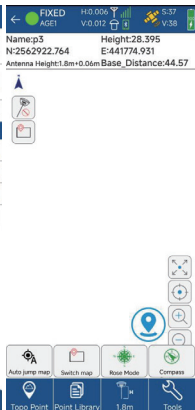

Figure 3.7-6

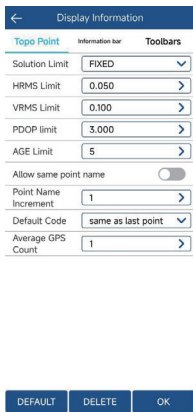

Figure 3.7-7

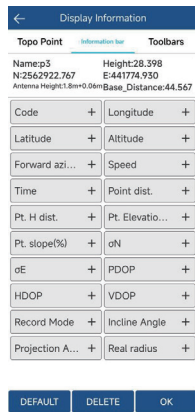

Figure 3.7-8

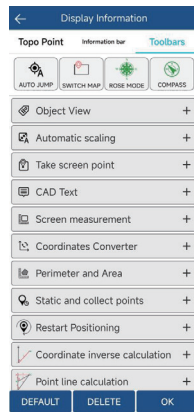

Figure 3.7-9

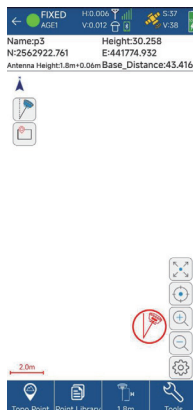

Figure 3.7-10



Figure 3.7-11

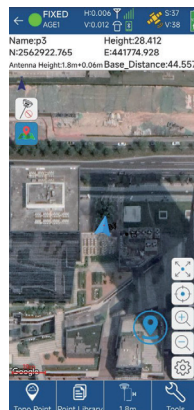





Figure 3.7-12

### 3.8 Tilt Survey

The tilt survey function requires the instrument to have a tilt module. Instruments with this function can do the following:

1. The accuracy of the instrument can be maintained within 2cm within the tilt range of 60 °;
2. The calibration process is simple, just shake the centering pole back and forth in place;
3. Support centering pole calibration, which can eliminate the survey error caused by the curvature of the centering pole.

Click [Survey]→ [Point Survey] to enter the point Survey page, click the tilt survey icon in the upper left corner  to turn on the tilt survey function. When turned on, the icon is . Then follow the pop-up prompts, as shown in Figure 3.8-1, and enter the antenna height parameters (centering pole height) according to the actual situation.

At this time, the instrument needs to be in a fixed state. Refer to the pop-up animation, as shown in Figure 3.8-2 , shake the centering pole back and forth for 5 to 10 seconds, then rotate 90°, and continue to shake the centering rod back and forth until the measurement icon changes to , as shown in Figure 3.8-3 , and then you can perform tilt survey.

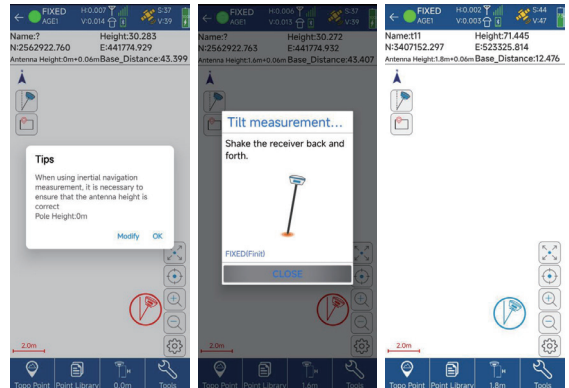

Figure 3.8-1



Figure 3.8-2

Figure 3.8-3

### 3.9 Laser Survey

Laser Survey requires connecting to an instrument with laser measurement. It is a more convenient way of point survey. It can measure wherever the laser can illuminate, and can overcome obstacles, saving time and effort. When connecting to an instrument with laser function, a laser measurement icon will appear on the measurement interface. When the laser measurement interface is turned on, the instrument will emit a green laser. The coordinates of the place where the laser illuminates can be measured.

Connect the receiver via WiFi, when you are using laser measurement, the real-time laser position will be shown on the screen. Click [Survey] → [Laser Survey] to enter the laser measurement interface, as shown in Figure 3.9-1. Follow the pop-up prompts and enter the antenna height parameters (centering pole height) according to the actual situation, as shown in Figure 3.9-2. At this time, the instrument needs to

be in a fixed state, as shown in Figure 3.9-3. Click  the icon and refer to the pop-up animation, as shown in Figure 3.9-4, shake the centering pole back and forth for 5-10s, then rotate 90, and continue to shake the centering pole back and forth until the measurement icon changes to , as shown in Figure 3.9-5. Click the  icon to complete the laser measurement data collection. In this interface, write the laser measurement point name and code, and you can see the laser measurement distance and measurement accuracy.

Click [Point Library] to view laser measurement points and common measurement points, as shown in Figure 3.9-6.

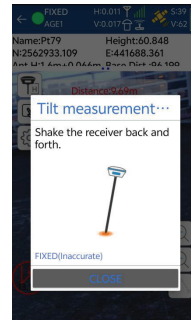

Figure 3.9-4

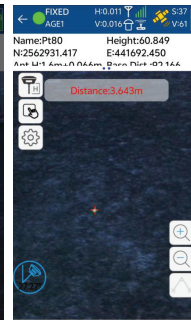

Figure 3.9-5

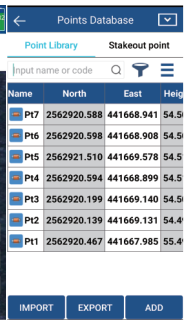

Figure 3.9-6

## 3.10 Point Stakeout

Click [Survey]→ [Point Stakeout] to enter the point stakeout library interface, as shown in Figure 3.10-1. Point stakeout means finding the location of a point through coordinate points in the field when the coordinates of the point are known. Points that have not been staked out and those have been staked out will be displayed. Click the stakeout point to edit, view details, stake out, and delete the stakeout point, as shown in Figure 3.10-2. The points to be staked out are part of the coordinate point library. The operations of adding, removing, importing, and exporting stakeout points are the same as those in the coordinate point library. Removing points from the points to be staked out does not actually delete points in the point library. You can also select points from the coordinate points (all points in the coordinate point library) for stakeout. After selecting points for stakeout, enter the point stakeout interface, as shown in Figure 3.10-3.

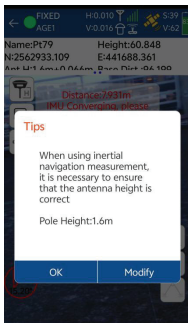

Figure 3.9-1

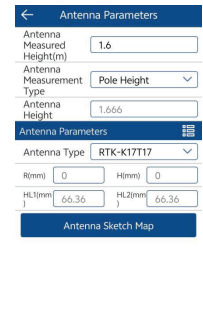



Figure 3.9-2



Figure 3.9-3

Click the icon  to enter the layout setting interface, as shown in Figure 3.10-4, where you can set the prompt range, layout tolerance, etc. You can also set the reference direction to east, south, west, north, front, back, left, right, and voice broadcast.

The layout of the point stakeout interface is similar to that of point survey, but there are some differences. The fill and cut values of the southeast, northwest, and northeast deviation values from the target are displayed in the status information bar. The compass, the current positioning, the measurement type, coordinate point library, antenna height and tools, functions such as stake out the nearest point, stake out the previous point, and stake out the next point are displayed at the bottom of the drawing area.

Click [Nearest Point], as shown in Figure 3.10-5, to stake out the nearest point.

Click , as shown in Figure 3.10-6, to manually add stakeout points at any time.

### How could we reach the destination faster?

If the user has a good sense of direction, he can distinguish between east, south, west and north in real-time field work. In the layout compass display, he can directly see the continuity between the current positioning point and the target point, and just walk to the direction it points to. As shown in Figure 3.10-3, you can find the target point Pt 1 by walking southwest.

What if the user has a poor sense of direction and cannot distinguish between east, south, west and north? You can look at the small arrow of the current location. The direction of this small arrow is the direction of the tablet when it is placed flat. As shown in Figure 3.10-3, the current

tablet is pointing to the south. You can turn the tablet to point to the same direction. When the tablet's direction coincides with the current point and the target point, it means that the tablet's direction is consistent with the target point. At this time, follow the tablet's direction and move forward.

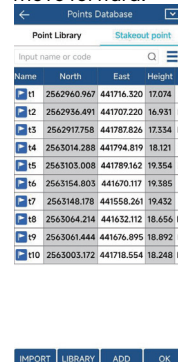

Figure 3.10-1

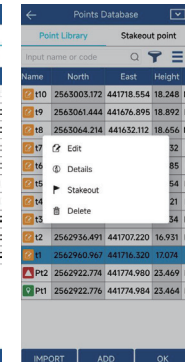

Figure 3.10-2

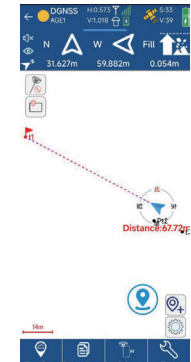

Figure 3.10-3

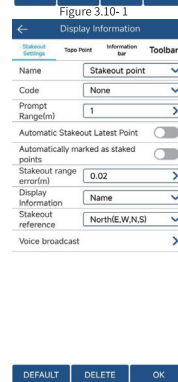

Figure 3.10-4



Figure 3.10-5

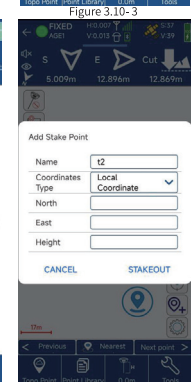

Figure 3.10-6



### 3.11 AR Stakeout (Communication mode needs to select WIFI)

AR stakeout needs to be connected to an instrument with AR function via WIFI to be displayed. It can provide high-definition real-scene stakeout function and better real-scene stakeout application to help you stake out the target in one shot.



1. Click [Device]→ [Communication] to enter the communication settings interface, as shown in Figure 3.11- 1. Select the device type (RTK), communication mode (WIFI), and then click [ Search], as shown in Figure 3.11- 2, view the WIFI device list, select the corresponding device serial number (default device number), and click [Connect] to complete the device connection, as shown in Figure 3.11- 3. After the device is successfully connected, it will directly return to the device interface.

2. Configure the rover to achieve a fixed solution state, refer to Section 3.2.

**Note:** To use the Phone Internet, the controller needs to have a SIM card inserted to connect to the Internet.

Click [Survey]→ [Point Stakeout] to enter the point stakeout library interface, as shown in Figure 3.11-4. The points to be staked will display the unstaked points and the staked points. Click the staked point to edit, view the details, stake out and delete the staked point, as shown in Figure 3.11-5. After selecting the point to stake out, enter the point stakeout interface, as shown in Figure 3.11-6. Click the tilt survey icon in the upper left corner  to turn on the tilt measurement function, as shown in Figure 3.11-7. When it is turned on, the icon is .

Then follow the pop-up prompts and enter the antenna height parameters (centering rod height) according to the

actual situation , as shown in Figure 3.11- 8. At this time, the device needs to be in a fixed state, shake the centering rod back and forth for 5~10s, then rotate 90°, and continue to shake the centering rod back and forth until the measurement icon changes to , as shown in Figure 3.11- 9. Click the AR icon  in the upper left corner, as shown in Figure 3.11- 10, to enter AR real-scene stakeout.

Finally, follow the arrow direction and distance indication to navigate to the area close to the stakeout point, as shown in Figure 3.11-11. When the tip of the centering rod coincides with the marked point, as shown in Figure 3.11-12, the AR real-scene stakeout is completed. At this time, you can click the measurement icon and choose to stake out the next point, previous point, or stake out again according to the pop-up prompt.

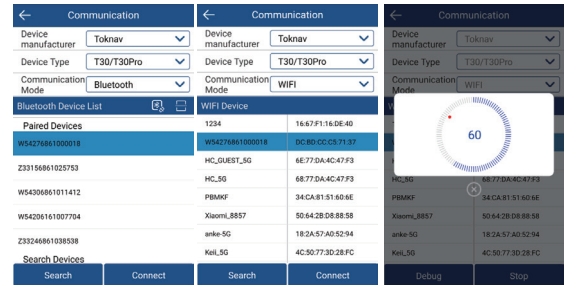

Figure 3.11-1

Figure 3.11-2

Figure 3.11-3

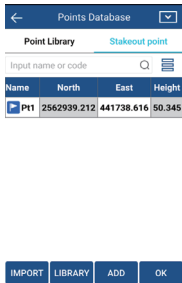

Figure 3.11-4

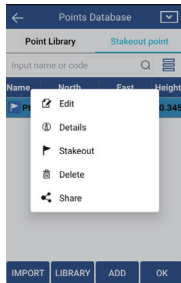

Figure 3.11-5



Figure 3.11-6

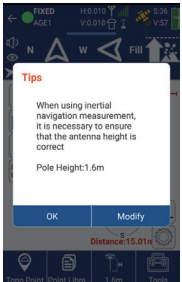

Figure 3.11-7



Figure 3.11-8



Figure 3.11-9

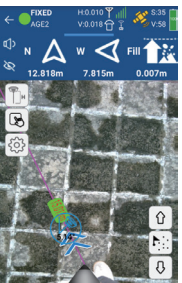

Figure 3.11-10

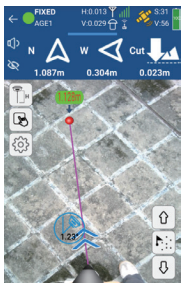

Figure 3.11-11

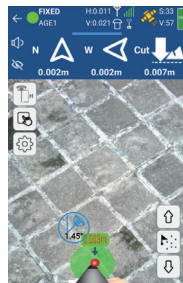

Figure 3.11-12

## 3.12 Localization

Click [Project]→[Localization], as shown in Figure 3.12-1, you can import control point parameters in various formats, or export control point data into files by third-party software. The high-precision position obtained by the software from the GNSS device is the latitude and longitude coordinates of satellite positioning, but in actual project operations, the plane coordinates on the ground are ultimately required for survey and application. If the customer has coordinates conversion parameters, the coordinate system parameter values can be set directly in the coordinate system (details 2.3). If the customer does not have specific coordinate system parameters, but has corresponding latitude and longitude coordinates and plane coordinates, we call them control points. In the case of control point data, this function can be used to calculate the conversion parameters and apply them to project operations.

Click [Add], as shown in Figure 3.12-2, you can manually enter the control point, or choose to import it from the coordinate point library, as shown in Figure 3.12-3. In the control point list, select the data item to modify, edit and delete the control point parameters, as shown in Figure 3.12-4.

After editing the control point parameters, calculate the conversion parameters for the control points. Click [Calculate Method] to pop up the conversion parameter condition settings, as shown in Figure 3.12-5. Coordinate conversion methods include plane correction, vertical correction, elevation fitting and seven parameters, which can be all or part of the combination. As long as the

corresponding accuracy is achieved within the accuracy range, the calculated conversion parameters are considered to be available. The plane correction model includes four parameters and horizontal adjustment. The elevation fitting method includes weighted average, plane fitting, surface fitting and vertical adjustment. Usually, if the operating range is very wide, seven parameters are needed to meet the accuracy requirements of all control points. If the operating range is relatively small, plane correction can usually achieve the corresponding accuracy.

After configuring the calculation conditions, click [Calculate] to display the calculation results of the conversion parameters and the residuals of each control point, as shown in Figure 3.12-6. After calculating the conversion parameters, you can export the calculation report for project review. If the conversion parameters are qualified, apply the parameters to the project and you can perform the surveying work normally.

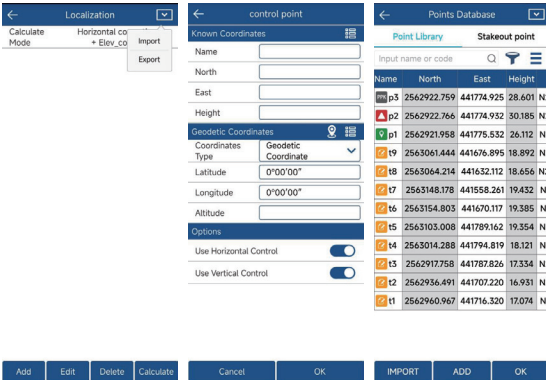

Figure 3.12-1

Figure 3.12-2

Figure 3.12-3

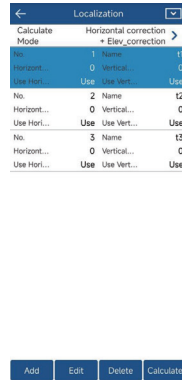

Figure 3.12-4

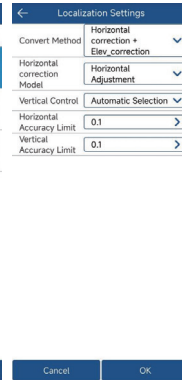

Figure 3.12-5

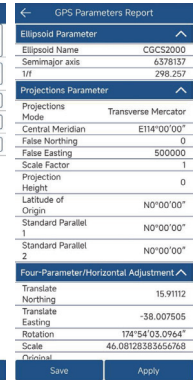





Figure 3.12-6

### 3.13 Calibrate Point

Click [Project]→ [Calibrate Point], as shown in Figure 3.13-1. In actual application, GNSS equipment obtains high-precision position by combining differential data of base station with solution. Here we know the coordinate position of base station. In fact, the high-precision position output by GNSS equipment is the relative position of base station. In actual application, some users using differential data of CORS reference station, there are also quite a few users using differential data of base station transmitted by their own GNSS equipment. When transmitting differential data by building their own stations, a project may involve starting base station multiple times. When initiating the base station, the starting position and starting coordinates of base station may change, and the starting coordinates may not be correct. In the absence of calibration, the coordinates of rover obtained by using these base station

differentials may be wrong (at the same location, the coordinates measured by previous differential data are different from the coordinates obtained by new differential data). Therefore, when the rover receives new base station differential data for surveying, it needs to perform points calibration so that the coordinates obtained by software match the coordinates obtained by connecting to the last base station. After the starting coordinates or starting position of the base station changes, a known position needs to be used to calibrate the coordinates correctly.

Click [Base Point Calibration], as shown in Figure 3.13-2, and click  to select a known point in the coordinate point library (use the coordinates measured by the base station at a certain location last time). Then click [Calculate] and apply.

Click [Marker Point Calibration], as shown in Figure 3.13-3, and click  select a known point in the coordinate point library (use the coordinates measured by the base station at a certain location last time), then place the GNSS device at the location of the known point. Click  to measure a new positioning point, and calculate the deviation value. Click [Apply], and the coordinates received by the software will match the coordinates measured last time.

The base station coordinates change and remind you whether to recalibrate. If the base station coordinates change when receiving the differential signal from the self-built base station, it means that the points calibration of base station is required and needs to be re-calibrated.

**Note:** The CORS reference station is a long-term operating reference station whose position and startup coordinates will not change. If the differential data of the CORS reference station is used, the received coordinates

may change, the obtained coordinates are still correct and no translation calibration is required.

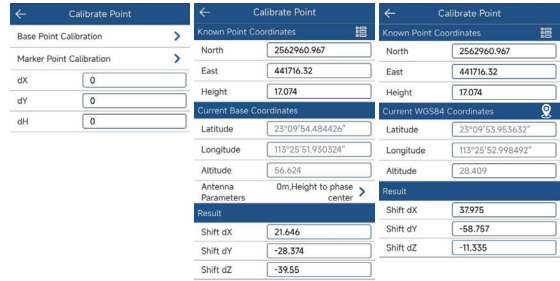



Figure 3.13-1      Figure 3.13-2      Figure 3.13-3

### 3.14 Coordinate Point library

Click [Project]→ [Points Database], as shown in Figure 3.14- 1. Here you can view and manage the point data in the project, including adding, editing, deleting, and importing.

Click the upper right corner , as shown in Figure 3.14-2, to switch the display style of point information.

Click [Add], as shown in Figure 3.14-3, and you can manually enter the point name, code and corresponding coordinates;

Click [Import], as shown in Figure 3.14- 4, select the file format of the point data to be imported, and then select the data file to complete the data import.

Select the coordinate point and click [Edit], as shown in Figure 3.14-5, you can edit and modify the name and code of the coordinate point;

Click the upper right corner , as shown in Figure 3.14-6, to filter the point type.

Click the upper right corner  and the operation will pop up, as shown in Figure 3.14-1. You can perform batch deletion, data statistics, sorting and other functions as needed;

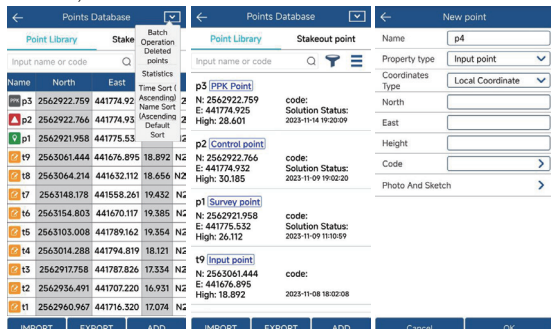

Figure 3.14-1

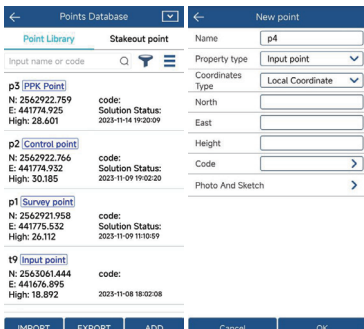

Figure 3.14-2

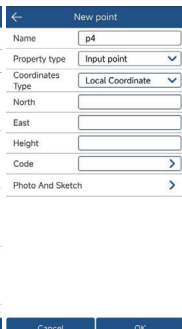

Figure 3.14-3



Figure 3.14-4

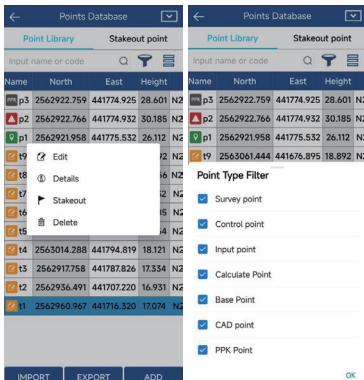

Figure 3.14-5

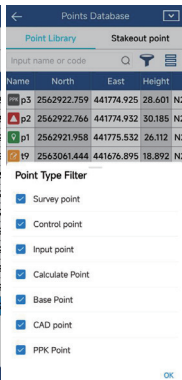

Figure 3.14-6

### 3.15 Export File

Click [Project]→ [ Export File], as shown in Figure 3.15-1, and select the type, file format, and angle format of the exported data as needed. Click [ Format Manager], as shown in Figure 3.15-2, select the file format of the data to be exported, and click [OK]. Click [User-defined Format], as shown in Figure 3.15-3, and you can manually create and edit the file format of the exported data.

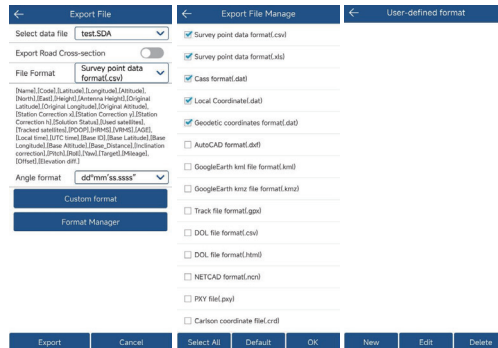

Figure 3.15-1

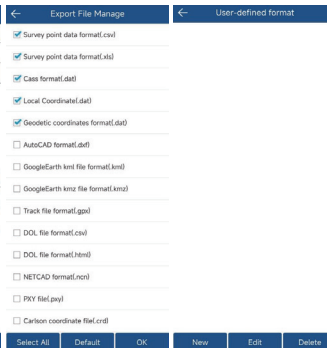

Figure 3.15-2



Figure 3.15-3

## 3.16 Device Information

Click [Device]→ [Device Information], as shown in Figure 3.16, to view basic information such as the GNSS device's working mode, device serial number, Firmware Version, Battery Power, expiry date, Satellites System, Antenna Parameters, etc.

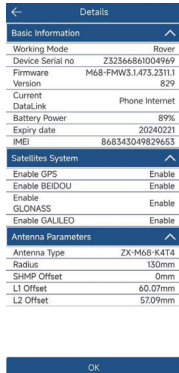

Figure 3.16

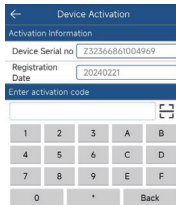

Figure 4.1

## 4. Device Activation and Software Registration

### 4.1 Device Activation

Click [Device]→ [Device Activation], as shown in Figure 4.1, to view the device serial number and expiry date. If the GNSS device has expired, you can obtain the registration code from the dealer and authorize the device here.

### 4.2 Software Registration

Click [Project]→ [About Software], as shown in Figure 4.2-1, to view the software version information and registration authorization information.

Click [Check for new versions], if there is a new version, the new version update information will pop up, click [Update] to update the software to the latest version. If there is no new version, it will prompt that it is already the latest version.

Click [Software Registration] to jump to the software registration interface, as shown in Figure 4.2-2, to view the activation ID and expiry date.

When you install the software for the first time, click [Online Activation] to activate it for three months of free trial.

Click [Manual Code Activation], as shown in Figure 4.2-3, enter the authorization code here or scan the QR code of the authorization code to activate the software.

If you need to replace a new controller, you can click [Transfer activation code] in the old controller, then enter the software registration of the new controller and enter the transferred activation code to activate the software.

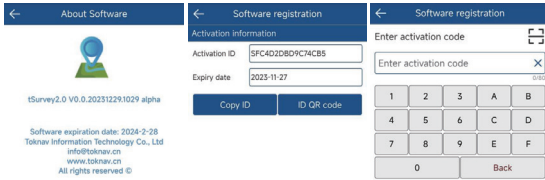

Figure 4.2-1



Figure 4.2-2

Figure 4.2-3

## 5. Built-in Radio

T50 is equipped with a 1.5Watt digital radio that supports integrated transmission and reception. Users can choose three power levels: low (0.5W), and high (1.5W).

**Note:** Every time you set the data link to the built-in radio, you need to install the radio antenna in advance. Please open the UHF radio cover on the bottom of the housing and then install it.

### 5.1 Radio Protocol

The device currently supports the following 10 radio protocols, which you can adjust it according to your needs.

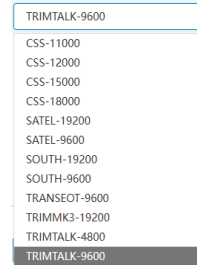

### 5.2 Default Channel Frequency

The device has 16 default channel frequencies, and the frequency of each channel supports custom configuration modification.

aisle	Frequency/MHz
1	463.125
2	464.125
3	465.125
4	466.125
5	463.625
6	464.625
7	465.625
8	466.625
9	463.375
10	464.375
11	465.375
12	466.375
13	463.875
14	464.875
15	465.875
16	466.875

## 6. Technical Indicators

SYSTEM	
HARDWARE SYSTEM	ARM Cortex-A7 1.8GHz
OS	Linux
GNSS	
GPS	L1C/A, L1C, L2P(Y), L2C, L5
GLONASS	L1, L2, L3
BDS	B1I, B2I, B3I, B1C, B2a, B2b(PPP)
GALILEO	E1, E5a, E5b, E6(PPP)
OZSS	L1, L2, L5
SBAS	L1(PPP)
NavIC (IRNSS)	L5*(Requires firmware support)
Channel	1408
Standard Output	NMEA-0183
Correction I/O Protocol	RTCM.3.X
Frequency	20Hz max
Reacquisition Time	<1s
Cold Start Time	<40s
ACCURACY	
SINGLE (RMS)	Horizontal: 1.5m / Vertical: 2.5m
DGPS (RMS)	Horizontal: 0.4m / Vertical: 0.8m
RTK (RMS)	Horizontal: ± (8mm+1ppm) Vertical: ± (15mm+1ppm)
Time Accuracy(RMS)	20ns
Static(RMS)	Horizontal: ± (2.5mm+1ppm) Vertical: ± (5mm+1ppm)
Speed Accuracy(RMS)	0.03m/s
Tilt Compensation (< 60°)	<2cm
AR Stake Out Accuracy	Horizontal: ± (8mm+1ppm) Vertical: ± (15mm+1ppm)
Laser Measurement	≤ 2.5cm 3D error within 5m range

SYSTEM PLATFORM	
Bluetooth	BR+EDR+BLE
WIFI	802.11 b/g/n
Network	LTE FDD: B1/2/3/4/5/7/8/12/13/ 18/19/20/25/26/28
	LTE TDD: B38/39/40/41 WCDMA: B1/2/4/5/6/8/19 GSM: B2/3/5/8
Storage	32GB storage
Radio	Integrated high-power transceiver Frequency Range: 410~470MHz Power: 0.5W/1.5W Protocols: TRIMTALK, TRIMMK3, SOUTH, TRANSEOT, SATEL, LORA Air Baud Rate: 4800, 9600, 19200
	Type: Class 3R Range: 100m Precision: ±5mm±100*10~6*D, (D: Measurement Distance) Wavelength: 520±20nm Power: 3.8mW
Laser Module	Sensor: 1/3.06 inch Resolution: 4224x3200 FOV: D44°H35°V26.5° Distortion: < 1%
Laser Assist Camera	AR Stakeout Supported Sensor: 1/2.8 inch Aperture: f/2.5 Resolution: 1920*1080 FOV: 69.3° ± 3° Distortion: < 0.38%
AR Camera	

BATTERY / CHARGE	
Capacity	74V, 6500mAh
Endurance	Over 16 hours(when applying controller network mode)
Charging	USB PD 15V/2A 5V/3A

ENVIRONMENT	
Operating Temperature	-30°C~+65°C
Storage Temperature	-40°C~+85°C
Shock Resistance	Can withstand a 1.5m drop at normal temperatures
Protection Rating	IP68

PHYSICAL	
Materials	Magnesium alloy casing with ABS/PC plastic top cover
Dimensions	φ132 * 83mm
Weight	770g

ACCESSORIES	
T50	1 Unit
Type-C power adapter	2 PCS
Type-C To Type-C	1PCS
Radio Antenna	1PCS

 [www.toknav.cn](http://www.toknav.cn)
 [info@toknav.cn](mailto:info@toknav.cn)

Manufacturers may update parameters at any time, please refer to the latest product information.



Europe, North & South America  
 Tel & WhatsApp: +1 (323) 847-7713 (Ian)  
 Asia, Africa & Oceania  
 Tel & WhatsApp: +86 139 2607 5986 (Jeffrey)

Guangzhou Toksurvey Information Technology Co., Ltd  
 No. 9 Caipin Road, Building B, Room 801-6,  
 Huangpu District, Guangzhou, China